

FOOTMOTION PLATING SYSTEM

FOOTMOTION PLATING SYSTEM - BASE

INSTRUMENTS



Screw rack

- RLT3.5Lxx Ø3.5 mm non locking screws (L10 to 40 mm)
- RLT2.8Lxx Ø2.8 mm non locking screws (L10 to 34 mm)
- SLT3.5Lxx Ø3.5 mm locking screws (L10 to 40 mm)
- SLT2.8Lxx Ø2.8 mm locking screws (L10 to 34 mm)

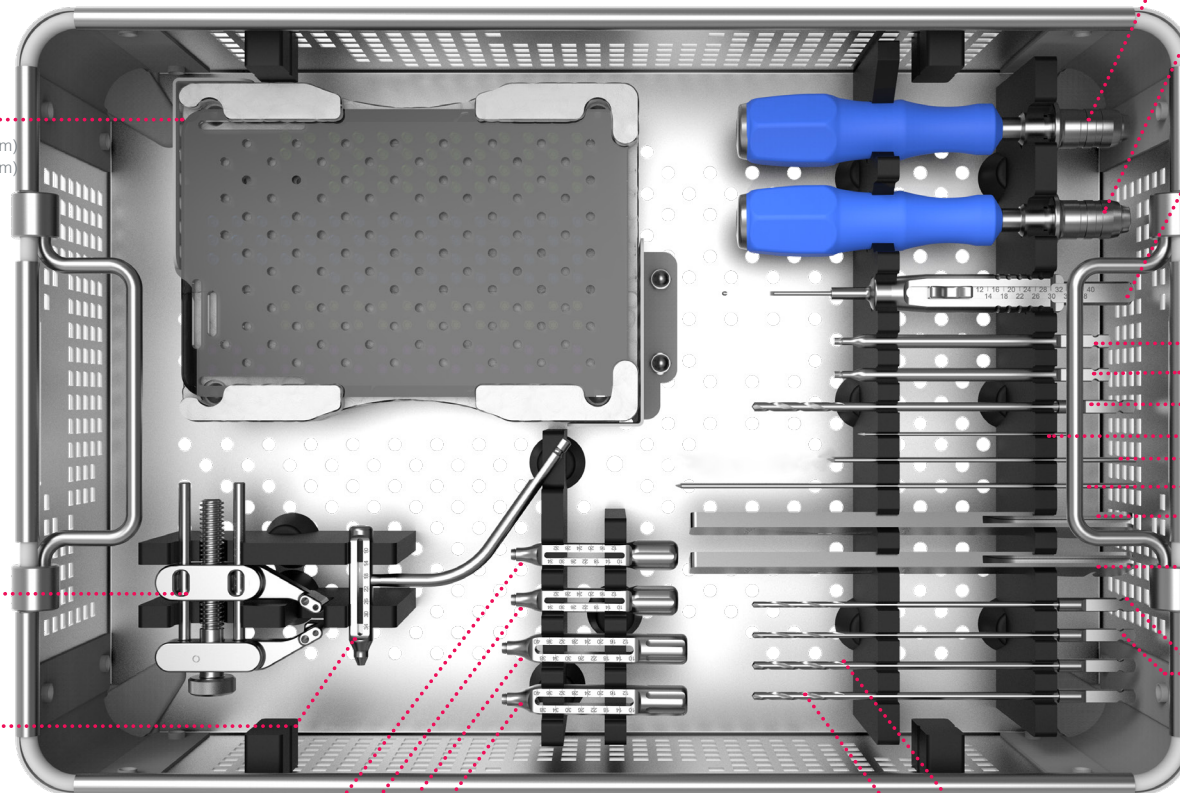
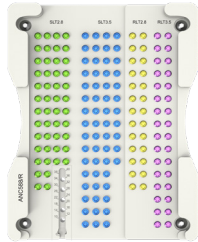

ANC642 Opening wedge osteotomy instrument

ANC586 Ø2.0 mm non threaded bent guide gauge for Ø2.8 mm screws

ANC576 Ø2.0 mm threaded guide gauge for Ø2.8 mm screws (x2)

ANC577 Ø2.7 mm threaded guide gauge for Ø3.5 mm screws (x2)

ANC350 Ø4.5 mm AO quick coupling handle - Size 1 (x2)

ANC589 Length gauge for Ø2.8 and Ø3.5 mm screws

ANC575 T8 quick coupling screwdriver (x2)

ANC611 Ø3.0 mm quick coupling drill bit - L125 mm

Pins

- 33.0212.070 Ø1.2 L70 mm (x5)
- 33.0216.100 Ø1.6 L100 mm (x5)
- 33.0216.150 Ø1.6 L150 mm (x5)

ANC578 Bending pliers (x2)

ANC590 Ø2.0 mm quick coupling drill bit - L125 mm (x2)

ANC591 Ø2.7 mm quick coupling drill bit - L125 mm (x2)

FOOTMOTION PLATING SYSTEM

FOOTMOTION PLATING SYSTEM - SUPERIOR LEVEL

PLATES AND REAMERS



1st MTP Arthrodesis plates

- FMTGD1 Left - Size 1
- FMTDD1 Right - Size 1
- FMTGD2 Left - Size 2
- FMTDD2 Right - Size 2
- FMTGD3 Left - Size 3
- FMTDD3 Right - Size 3
- FMTGDN1 Left - Narrow - Size 1
- FMTDDN1 Right - Narrow - Size 1
- FMTGDN2 Left - Narrow - Size 2
- FMTDDN2 Right - Narrow - Size 2

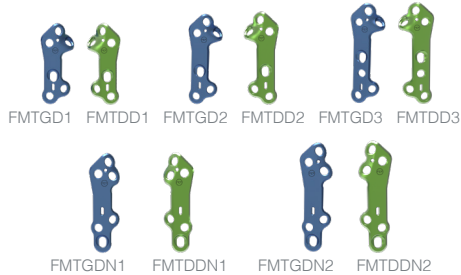

1st MTP arthrodesis revision plates

- FMTGDN4 Left - Narrow - Size 4
- FMTDDN4 Right - Narrow - Size 4
- FMTGD4 Left - Size 4
- FMTDD4 Right - Size 4

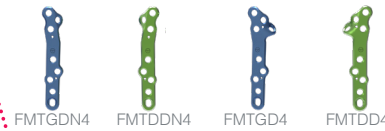

Isolated Lisfranc Arthrodesis plates

- FUTGD1 Left - Size 1 (x2)
- FUTDD1 Right - Size 1 (x2)
- FUTSD1 Size 1 (x2)



Straight plates

- FUTS1 Size 1 - 2 holes
- FUTS2 Size 2 - 3 holes
- FUTS3 Size 3 - 4 holes
- FUTS4 Size 4 - 5 holes
- FUTS5 Size 5 - 6 holes
- FUTS6 Size 6 - 7 holes



Talo-Navicular Arthrodesis plates

- FTTGD1 Left - Size 1
- FTTDD1 Right - Size 1
- FTTGD2 Left - Size 2
- FTTDD2 Right - Size 2
- FTTSM1 Medial - Size 1
- FTTSM2 Medial - Size 2



Metatarsal basal opening wedge plates

- FOTSM0 0 mm
- FOTSM3 3 mm
- FOTSM4 4 mm
- FOTSM5 5 mm

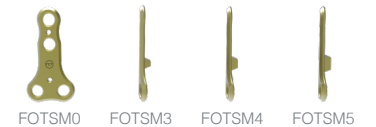

Medial Lisfranc Arthrodeses plates

- FETGD1 Left - Size 1
- FETDD1 Right - Size 1



Dorsal Lisfranc Arthrodeses plates

- FDTSDN1 Narrow
- FDTSDS1 Standard
- FDTSDW1 Wide

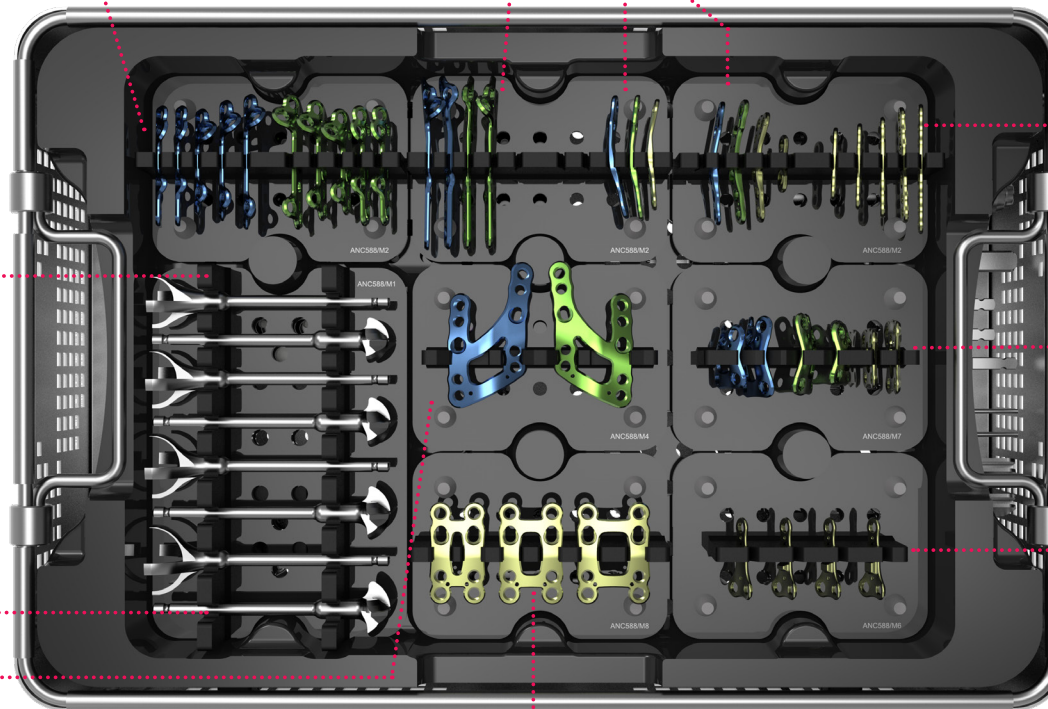

Reamers

- ANC567 Ø16 mm convex reamer
- ANC568 Ø16 mm concave reamer
- ANC569 Ø18 mm convex reamer
- ANC570 Ø18 mm concave reamer
- ANC571 Ø20 mm convex reamer
- ANC572 Ø20 mm concave reamer
- ANC573 Ø22 mm convex reamer
- ANC574 Ø22 mm concave reamer

FOOTMOTION PLATING SYSTEM - OPTIONS

MIBO OPTION

ANC1059 Ø2.0 mm threaded guide gauge for Ø2.8 mm screws - MIS MIBO (x3)

33.0212.120 Pin Ø1.2 L120 mm (x5)

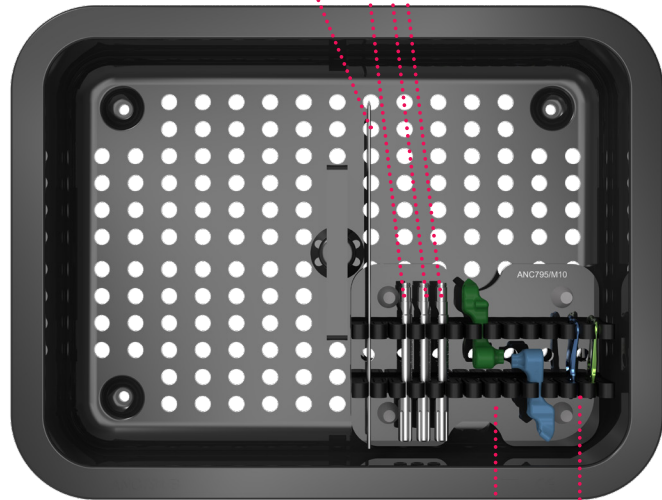

MIS guides for metatarsal basal closing wedge

ANC1057 Left
ANC1058 Right

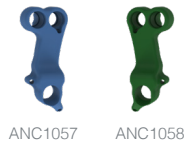

Metatarsal basal closing wedge plates

FFTGD1 Left - Size 1
FFTDD1 Right - Size 1



FLATFOOT OPTION

Calcaneal displacement osteotomy plates

FATSL5 5 mm
FATSL7.5 7.5 mm
FATSL10 10 mm

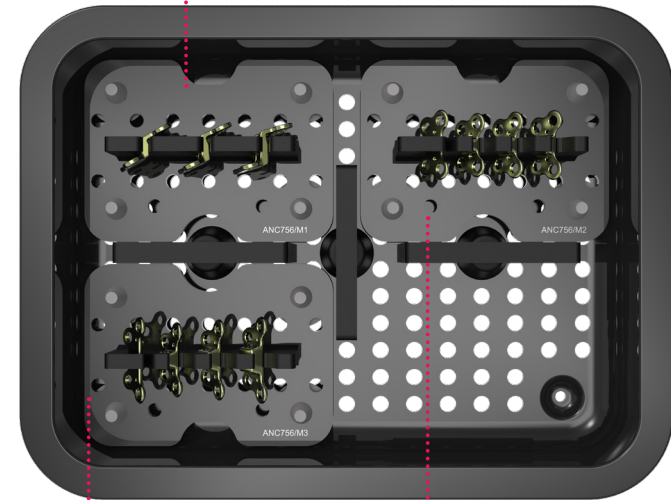

Cotton osteotomy plates

FCTSM0 0 mm
FCTSM4.5 4.5 mm
FCTSM5.5 5.5 mm
FCTSM6.5 6.5 mm



Evans osteotomy plates

FVTSL0 0 mm
FVTSL6 6 mm
FVTSL8 8 mm
FVTSL10 10 mm



FOOTMOTION PLATING SYSTEM

FOOTMOTION PLATING SYSTEM - OPTIONS

Ø4.0 MM OPTION

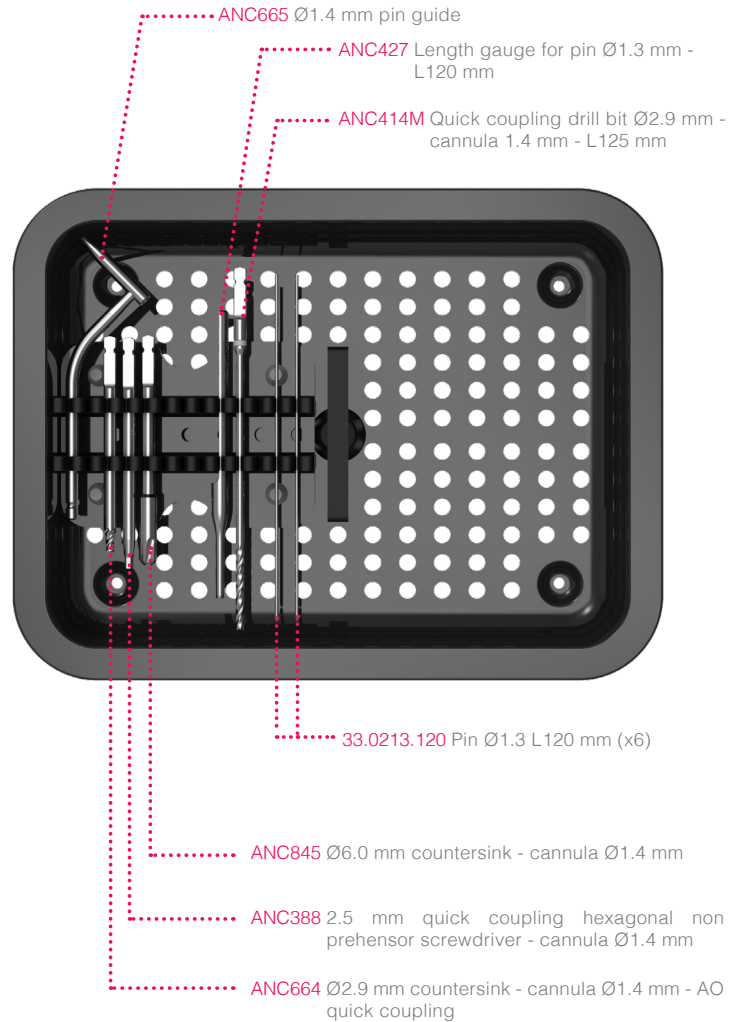

STERILE IMPLANTS COMPATIBLE WITH THE Ø4.0 MM OPTION



Ø4.0 MM COMPRESSIVE SCREWS

Ref.	Description
H1.4QT4.0Lxx-ST	Self-drilling compressive screw - Ø4.0 mm - cannulated Ø1.4 mm - short thread - STERILE - L26 to 48 mm (2 mm incrementation)

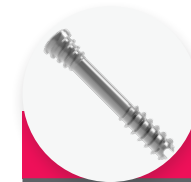

Ø4.0 MM SELF-COMPRESSIVE SCREWS

Ref.	Description
H1.4IFT4.0Lxx-ST	Self-drilling self-compressive screw - Ø4.0 mm - cannulated Ø1.4 mm - STERILE - L26 to 48 mm (2 mm incrementation)



WASHERS*

Ref.	Description
WASH-T4-ST	Washer - STERILE

* Compatible with the H1.4QT4.0Lxx-ST screws

FOOTMOTION PLATING SYSTEM

> FOOTMOTION PLATING SYSTEM - OPTIONS

LAG SCREWS OPTION

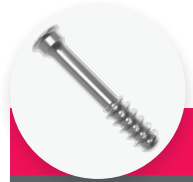

Ø3,5 MM LAG SCREWS

Ref.	Description
QLT3.5Lxx-ST	Lag screw - Ø3.5 mm - STERILE - L20 to 40 mm (2 mm incrementation)

FOOTMOTION PLATING SYSTEM

FOOTMOTION PLATING SYSTEM LAPIDUS - BASE

INSTRUMENTS



Screw rack

- RLT3.5Lxx Ø3.5 mm non locking screws (L10 to 40 mm)
- RLT2.8Lxx Ø2.8 mm non locking screws (L10 to 34 mm)
- SLT3.5Lxx Ø3.5 mm locking screws (L10 to 40 mm)
- SLT2.8Lxx Ø2.8 mm locking screws (L10 to 34 mm)

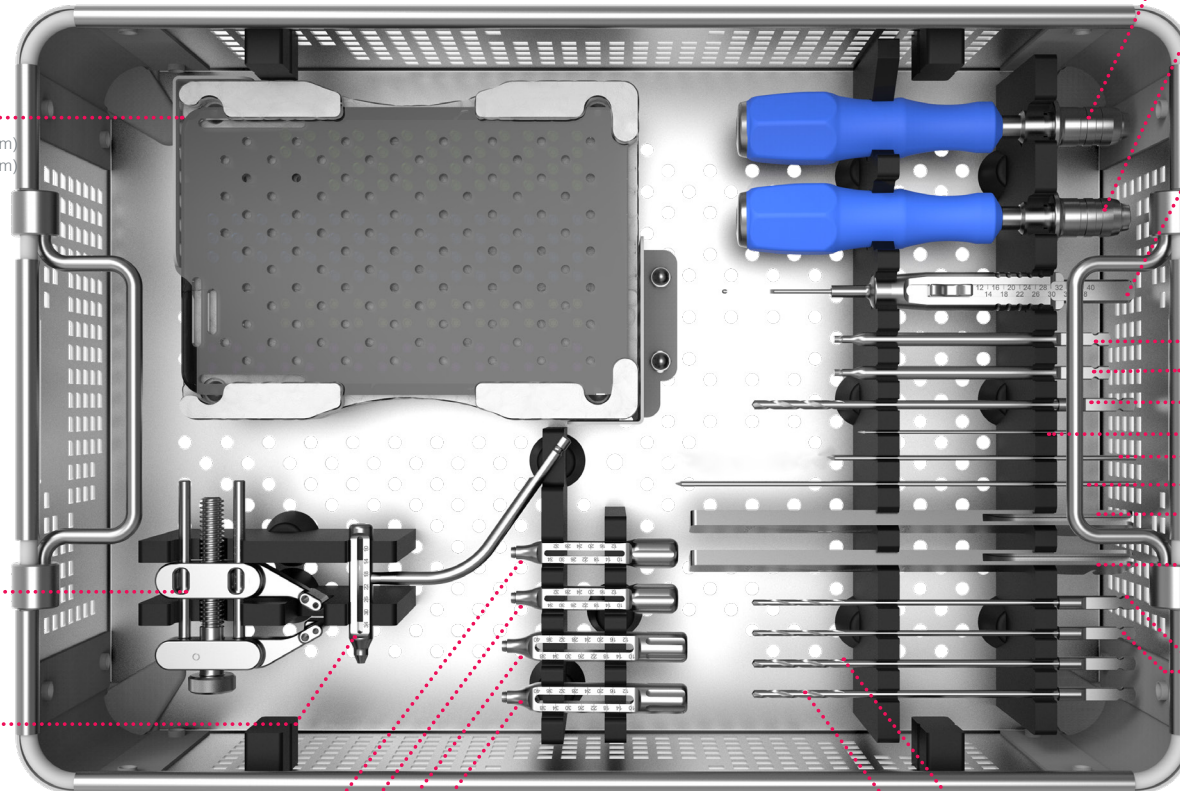
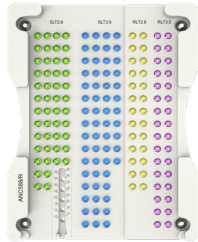

ANC642 Opening wedge osteotomy instrument

ANC586 Ø2.0 mm non threaded bent guide gauge for Ø2.8 mm screws

ANC576 Ø2.0 mm threaded guide gauge for Ø2.8 mm screws (x2)

ANC577 Ø2.7 mm threaded guide gauge for Ø3.5 mm screws (x2)

ANC350 Ø4.5 mm AO quick coupling handle - Size 1 (x2)

ANC589 Length gauge for Ø2.8 and Ø3.5 mm screws

ANC575 T8 quick coupling screwdriver (x2)

ANC611 Ø3.0 mm quick coupling drill bit - L125 mm

Pins

- 33.0212.070 Ø1.2 L70 mm (x5)
- 33.0216.100 Ø1.6 L100 mm (x5)
- 33.0216.150 Ø1.6 L150 mm (x5)

ANC578 Bending pliers (x2)

ANC590 Ø2.0 mm quick coupling drill bit - L125 mm (x2)

ANC591 Ø2.7 mm quick coupling drill bit - L125 mm (x2)

FOOTMOTION PLATING SYSTEM

FOOTMOTION PLATING SYSTEM LAPIDUS - SUPERIOR LEVEL



PLATES AND INSTRUMENTS

Plantar Lapidus arthrodesis plates

- FLTSV1 Size 1
- FLTSV2 Size 2
- FLTSV3 Size 3



Narrow plantar Lapidus arthrodesis plates

- FLTG0 Left - Narrow - Size 0
- FLTD0 Right - Narrow - Size 0
- FLTG1 Left - Narrow - Size 1
- FLTD1 Right - Narrow - Size 1
- FLTG2 Left - Narrow - Size 2
- FLTD2 Right - Narrow - Size 2



Dorso-medial Lapidus arthrodesis plate

- FLTSM1 Size 1



- ANC841 Ø2.7 mm non threaded bent guide gauge for Ø3.5 mm screws

- ANC861 Ø2.7 mm cannulated bending drill guide (x2)

Medio-plantar Lapidus arthrodesis plates

- FLTGM0 Left - Size 0
- FLTDM0 Right - Size 0
- FLTGM1 Left - Size 1
- FLTDM1 Right - Size 1
- FLTGM2 Left - Size 2
- FLTDM2 Right - Size 2



Isolated lisfranc plates

- FUTGD1 Left - Size 1
- FUTDD1 Right - Size 1
- FUTSD1 Size 1

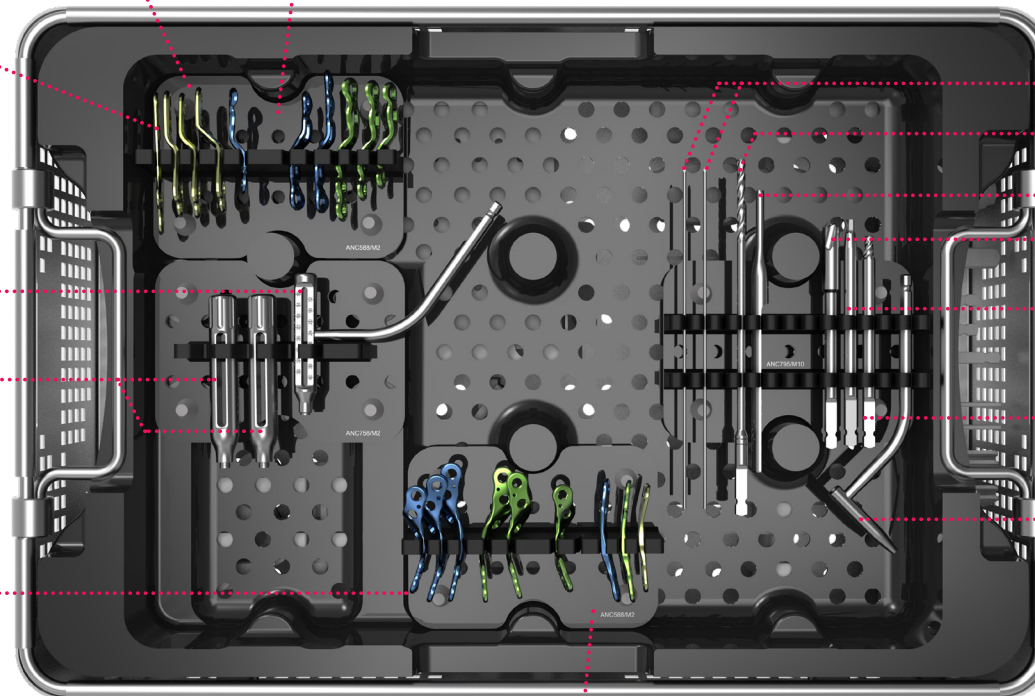

- 33.0213.120 Pin Ø1.3 L120 mm (x6)
- ANC414M Quick coupling drill bit Ø2.9 mm - cannula 1.4 mm - L125 mm
- ANC427 Length gauge for pin Ø1.3 mm - L120 mm
- ANC845 Ø6.0 mm countersink - cannula Ø1.4 mm
- ANC388 2.5 mm quick coupling hexagonal non prehensor screwdriver - cannula Ø1.4 mm
- ANC664 Ø2.9 mm countersink - cannula Ø1.4 mm - AO quick coupling
- ANC665 Ø1.4 mm pin guide

FOOTMOTION PLATING SYSTEM

FOOTMOTION PLATING SYSTEM LAPIDUS - OPTIONS

SCREW OPTIONS



Ø4.0 MM COMPRESSIVE SCREWS

Ref.	Description
H1.4QT4.0Lxx-ST	Self-drilling compressive screw - Ø4.0 mm - cannulated Ø1.4 mm - short thread - STERILE - L26 to 48 mm (2 mm incrementation)



WASHERS*

Ref.	Description
WASH-T4-ST	Washer - STERILE

* Compatible with the H1.4QT4.0Lxx-ST screws



Ø4.0 MM SELF-COMPRESSIVE SCREWS

Ref.	Description
H1.4IFT4.0Lxx-ST	Self-drilling self-compressive screw - Ø4.0 mm - cannulated Ø1.4 mm - STERILE - L26 to 48 mm (2 mm incrementation)

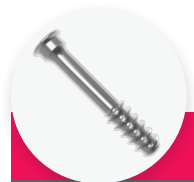

Ø3.5 MM LAG SCREWS

Ref.	Description
QLT3.5Lxx-ST	Lag screw - Ø3.5 mm - STERILE - L20 to 40 mm (2 mm incrementation)

